

JULY ISSUE

INSIDE :
REVIEWS

DESKCART
THE HOME ACCOUNTANT
THE ATARI ST FOR
BEGINNERS

F-18 HORNET

Drawn Using The Graphic Artist

- 1 SIDEWINDER AIR-AIR MISSILE
- 2 MISSILE LAUNCH RAIL
- 3 NAVIGATION LIGHT
- 4 WING FOLD HINGE JOINT
- 5AILERON
- 6 FLAP VANE
- 7 FLAP
- 8 LIGHT
- 9 RUDDER HYDRAULIC ACTUATOR
- 10 NAVIGATION LIGHT
- 11 FUEL JETTISON
- 12 MOVING TAILPLANE
- 13 TAILPLANE
- 14 ECM ANTENNA
- 15 RADAR WARNING ANTENNA
- 16 FORMATION LIGHTING STRIP
- 17 AFTERBURNER NOZZLE
- 18 NOZZLE ACTUATORS
- 19 MOVING TAILPLANE
- 20 TAILPLANE PIVOT MOUNTING
- 21 TAILPLANE HYDRAULIC ACTUATOR
- 22 TURBOFAN ENGINE
- 23AILERON HYDRAULIC ACTUATOR
- 24 WING FOLD ACTUATOR
- 25 LEADING FLAP ACTUATOR
- 26 WING TANK
- 27 EQUIPMENT GEARBOX
- 28 REAR LANDING GEAR
- 29 AUXILIARY FOWER TURBINE
- 30 SPARROW AIR-AIR MISSILE
- 31 LEADING FLAP DRIVE MOTOR
- 32 MAIN RETRACT ACTUATOR
- 33 FORWARD RETRACT ACTUATOR
- 34 LIQUID OXYGEN CONVERTER
- 35 BOARDING LADDER
- 36 FORWARD LANDING GEAR
- 37 CATAPULT LAUNCH STROP
- 38 CONTROL COLUMN
- 39 RUDDER PEDALS
- 40 AMMUNITION FEED CHUTE
- 41 PILOT HEAD
- 42 RADOME
- 43 RADAR SCANNER
- 44 RADAR EQUIPMENT BAY
- 45 ROMM ROTARY CANNON
- 46 WINDSCREEN
- 47 HEADS-UP DISPLAY
- 48 CANOPY
- 49 EJECTION SEAT
- 50 AVIONICS EQUIPMENT
- 51 SECOND SEAT SPACE
- 52 LEADING EDGE ROOT EXTENSION
- 53 FUSELAGE TANKS
- 54 LEADING EDGE FLAP
- 55 WING TANK

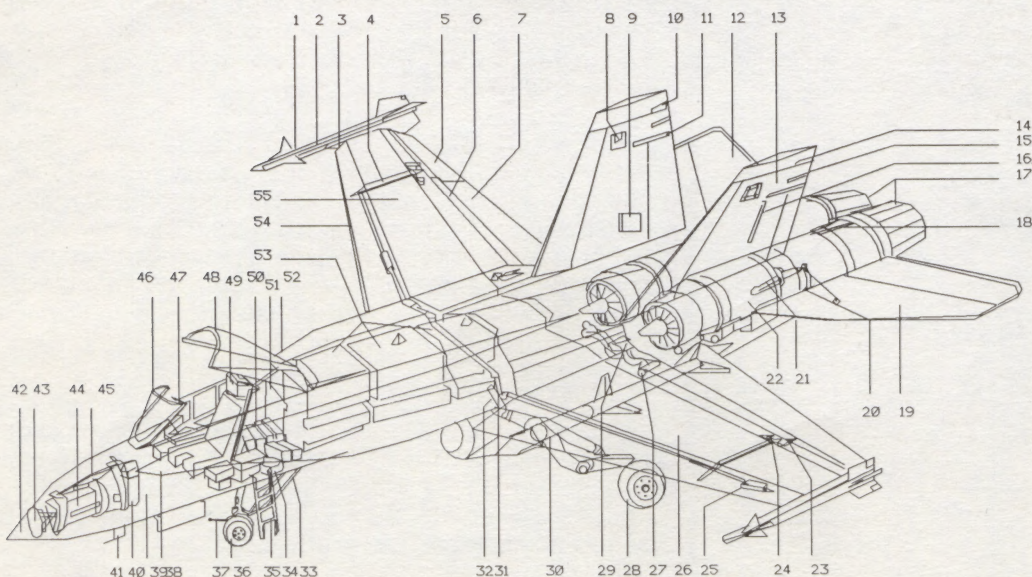



Table of Contents

- 2 CCD News
- 3 OS BUGS
- 3 CES News
- 6 Atari Scuttlebits
- 8 DeskCart
- 9 The Home Accountant
- 10 Atari ST for Beginners
- 15 More CES Reports
- 20 Editors Notes
- 21 Dal-Ace 1987 Survey

Computer Council of Dallas NEWS June, 1987

The May and June User Forums continued to grow, both in vendors and meeting rooms used. Attendance may be slightly suffering competition from the beautiful weather, but remains high. Further details below.

The financial growth is welcome and necessary. CCD's only source of income, table rentals in the vendor area, increased in May compared to April, and again in June, compared to May, because more tables were rented (a total of 49 in May and 54 in June, not counting club DOM's or several no-shows). Additionally, several expense items from prior months were received to the extent that CCD expenses are now essentially current. This allows more accurate budget projections for the rest of the year.

With more financial information, CCD is able to adopt a policy on audio-visual expenses. The overhead projectors, microphones, and so forth are rented by CCD for each meeting. In the future, CCD will pay for overhead projectors, marker and chalk boards, and microphones. Currently, this is the second highest meeting cost (behind our lease with INFOMART). If additional equipment is desired, affiliated groups must either bring it, or repay CCD for the rental costs incurred. For example, turning on a phone line costs \$40. The cost of individual items is available from the Events Coordinator and each representative. If special equipment is needed, as much notice as possible should be provided the Events Coordinator, so that equipment can be shared wherever possible, to reduce these costs. For additional information, see any CCD representative.

Each User Forum contains over 100 individually scheduled meetings. The hours of 9 AM and noon are the busiest. To assure adequate room availability, room requests must be turned in to the Events Coordinator by Friday of the week before the meeting (dates below). Rooms requests should be channeled through the appropriate program office of each affiliate, since only affiliated groups can reserve rooms.

After much research, INFOMART has agreed to provide standard plastic name badges (presumably like we used to get), individually printed, at a cost of \$0.25 each. Interested parties should contact their group officers.

Several children were stopped running loose in INFOMART at the June Forum. Remember that

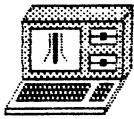

INFOMART requires that all children under the age of 16 be accompanied at all times by a parent or guardian. Rowdy or unruly behavior will NOT be tolerated! This is a necessary commitment by CCD and each affiliate to use INFOMART's facilities. Please act accordingly.

The survey forms filled out several months ago are now being analyzed. Hopefully preliminary results will be available next month.

Two organizations have applied for membership in CCD: the Chinese Information Resources Association and the North Texas Association for Artificial Intelligence. Discussion will occur at the next CCD board meeting, scheduled for July 13th.

CCD is trying to improve relations with the MIDI group affiliate. They have not nominated a representative on the board, attended the last several board meetings, or provided CCD with a copy of their bylaws. These actions are required of any affiliate per the bylaws. The Board intends to discuss what action(s) are appropriate in response to this continued failure to comply with affiliate responsibilities at the next board meeting. Comments and opinions should be directed to the appropriate affiliate officer or representative, or via feedback to this author via the Startext mailcode listed above.

Volunteers are urgently needed during both setup and breakdown. If you happen to arrive early (before 9 AM) or stay late (after 4 PM), drop by the Information Booth and see if you can help. It doesn't take too long, or involve much effort, but would be greatly appreciated.

Meeting dates for the next three months are: July 11, August 8, & September 12. See you there!

Some OS Bugs

By Ralph Walden

- Whether you are using a program, or writing one, there are some bugs in the Operating System you should be aware of. As far as I can tell, they are all related to the 40 folder access limit. The more folders you access, the more likely these problems will occur.

- If your program asks the OS to open the directory for a certain drive, you may or may not get

the directory of the drive you asked for. For example, A:.* might list all the files on drive B. Using the backslash will usually correct this, i.e., A:\.*.

- If you request the OS to open a specific file, it may not open it on the drive you asked for. For example, if you tried to open A:TEST.TXT, it might open the file on drive B. Using A:\TEST.TXT will usually correct this problem.

- If you request the OS to format a specific drive, it may or may not format that drive. For example, if you ask it to format drive A, it may format drive B. Fortunately, this error is rare, but it's a good idea to either remove or write protect any disk you don't want formatted.

- If you write to a file, and there is a bad sector, you may not get an error even with write verify on. The OS will return an okay status, even if nothing was written to the disk.

(JLP NOTE: This file was found in the DCOPY 1.91 ARC file. Anyone want to add to the list? Some of these I've seen, some I've not.)

Chicago -- CES NEWS

Saturday, May 30, 1987:

(c) 1987 CIS SYSOP*David G. Groves

From the Atari Booth, topped with a real Cessna Airplane, the word was "flying high with Atari". The theme followed through into the exhibit space where Flight Simulator II played from a cartridge on a large screen monitor inside the cockpit of a Cessna. Atari chose to push its game side, and the new computer lines were not being shown. There was a PC Clone getting minimal attention but the absence of MEGA ST's, Laser printers, 1200 baud modems, Blitter enhanced ST's, IBM emulator, and 80 Column Cards, left little doubt that this was to be a game show. Recently appointed Vice President and General Manager of US operations, J. J. (Jerry) Brown confirmed this in his press release of today stating "Atari intends to remain the leader in video game systems and to increase its share of the US personal computer market."



My first impression (as an Atari _Business_ computer user) were quite negative, since Atari's press releases emphasized games and game machines, seemingly ignoring the business computer market. Almost 2 pages of the 3 page advertising campaign announcement is devoted to game machine promotions planned for the balance of this year, including national TV spots starting in September, comic book ads, in-store hardware and software demos, and full repackaging of the game machines and XE's. Not until the back pages did we note that 4 TV ads (starting late 3rd quarter and running through New Years) and a substantial portion of the new advertising budget (quadrupled from previous levels) would be devoted to the ST's! (This as opposed to 3 new ads starting in September for the games). The budget also calls for some major print ads to follow and support the TV effort.

Now the pessimist will assume that Atari is bent on forgetting the computers in favor of games. The more business oriented will notice that Atari Stock and Sales of ST's have been doing rather well, and that in the introduction of the ST's and MEGA the games assets of the company were nearly step-children. Further, the XE is almost in direct competition with the ST's and likely in an overstocked condition at Atari. The optimist will, therefore, assume that Atari is on a campaign to liquidate the old stock in new boxes, maintain its game market share, and produce the liquidity and corporate energies to actively continue its ST advantage. In assessing Atari's strategies, one must remember that the manpower of this company has sorely lagged behind its growth in home computer market share, and that Atari had nothing to do with the conflicting schedules of CES and Comdex this year. With limited manpower and time to produce and to sell product, I am optimistic and feel that Atari made the right decisions in the face of the tough decision forced by The Interface Group's show timing. The balance of this quarter should tell!

ANTIC'S JUNE '87 CES REPORT: OPENING DAY OVERVIEW

By Nat Friedland, ANTIC Editor
ANTIC Publishing Inc.,
Copyright 1987
Reprinted by Permission.

Atari's 8-bit computer line is far from dead - with a new double-speed, double-density 5 1/4 inch disk drive due this summer, as well as the long-awaited 1200 baud plug-in modem and the 80-column box...plus the XE Game System that comes with 64K, a keyboard, a light gun and Flight Simulator II.

The ST has yet another new wave of remarkable and mind boggling products on the way. Within our first hour at CES we saw a 4-megabyte memory board that goes into any ST without soldering, and the Hybrid Arts ADAP Soundtrack CD-quality stereo sampling and editing system that

competes with the vastly more expensive Synclavier and Fairlight in high-end MIDI.

And these are just quick first impressions from the opening hours of a Consumer Electronics Show that supposedly was not going to produce any major new Atari announcements...

The first day of CES is still underway as I write this on Antic's trusty Radio Shack 100 in hopes of catching a special Saturday merge that ANTIC ONLINE has arranged with CompuServe. So let's get right to the opening round of news:

8-BIT UPDATE

We'll start with the good news for 8-bit users. The XF551 disk drive is the big surprise. It's a compact 5 1/4 inch drive in XE gray, about 3/4 the size of the now-discontinued 1050 drive and priced in about the same \$160 range as the 1050. The XF551 is also claimed to be 2.9 times faster than a 1050 and boasts true double density - as well as automatic compatibility with every other density format ever used for the 8-bit Atari. It seemed clear from talking to a number of Atari sources that a 3 1/2 inch disk drive for the 8-bit computers is now unlikely to be produced.

The XF551 drive will have a new ADOS operating system which is nearing completion by OSS, the creators of DOS 2 and DOS 2.5. Promised features of ADOS include a tree structure allowing directories and easy toggle between menu or command operations.

According to Atari's Jose Valdes, the key engineer/designer of the new XE products described in this dispatch, the first XF551 drives can be expected to start trickling into the stores by July. The same July arrival date now holds true for the 80-column XEP80 display box (reviewed in the July '87 Antic) and the new 1200 baud SX212 modem. Valdes says both products have been delayed by a wait for delivery of main chips, but all other components and packaging are stockpiled in readiness for assembly at Atari's Taiwan factory.

AtariWriter Plus 80 was operating on the XEP80 in a razor-sharp 80-column display at the Atari Booth. The SX212 modem will be bundled with a new version of Keith Ledbetter's famed Express software which the author is scheduled to demonstrate later in the show.



XE GAME SYSTEM

The first working pre-production prototypes of the XE Game System were on view atop the roof of Atari's large booth structure, along with a real Cessna airplane that Atari somehow got into the new CES North Hall. The Game System is essentially a two-piece 65XE computer that costs as much as a 130XE.

But instead of 128K memory, you get a light-gun, a joystick and three games - Flight Simulator II on cartridge, Missile Command in ROM and a pistol game called Bug Hunt. At least 18 arcade and disk best-sellers are now promised for Atari cartridge by Christmas, including 1 On 1, Gato, Midnight Magic, Karateka, Choplifter and Blue Max. Most titles are to sell for \$19.95 each.

Atari Software Director John Skruch says the XE can get as much as 256K on a bank-switching cartridge. Flight Simulator II only required 128K. Two hard-hitting TV commercials for the Game System were on Display. The system is designed to be sold in separate pieces overseas. Eventually the light-gun will be available in the USA as an 8-bit peripheral. An ST mouse will work on the XE Game System in trackball mode.

ANOTHER ST BONANZA

This CES had another dazzling array of ST computer products on display. We'll be looking at a lot more of them in our later reports. During just our first hours around the crowded Atari area, here's what we found that seemed especially impressive:

Micro D of Canada was showing a prototype 2/4Mb memory upgrade board that is supposed to install inside any ST without soldering. The Data-Free Board will sell for \$159 without RAM chips. The 4-megabyte upgrade requires 32 chips and the 2Mb takes 16. The chips cost \$30 each from Micro D or you can shop for a better price on your own. Hybrid Arts, the king of Atari MIDI developers, was showing their \$1995 ADAP Soundtrack digital sampling system, which will be on sale in July. ADAP offers the sound quality of compact disks - in true stereo if you get a dual hardware setup. On a stage in the Atari area, ADAP was in action - effortlessly pulling selected portions off any tape and manipulating the sound in real-time with a simple visual interface. Sounds could be played back in reverse, cut and pasted, stretched, faded and otherwise manipulated, as fast as you could click a mouse.

SUMMER CLEARANCE SALE
 25% OFF ANY ORDER

EZRAM™ 520



- Upgrades your 520 to 1 Meg of RAM
- Simple **solderless** push temp installation
- High quality gold plated contacts
- Easy to follow illustrated instructions
- Will not interfere with new blitter chip installation
- Free memory check and diagnostic software with additional accessory programs
- Instructional installation video available
- 6 month warranty

Suggested list \$199.00

Terrific Corp.
17 St. Mary's Court
Brookline, MA 02146
617-232-2317
User group discounts available

"I heartily recommend this upgrade to anyone who can use a screwdriver and a pair of long nose pliers."
ST Log March 1987

EZRAM, is a trademark of Terrific Corp. Atari and Atari 520ST are registered trademarks of Atari Corp.



Frank Foster of Hybrid Arts told Antic that Tom Hudson is looking into the ADAP math co-processor box for speeding up certain math-intensive operations of his graphics software (DEGAS, CAD-3D) such as ray tracing.

Springboard was showing their little-publicized ST conversion of Certificate Maker at the Atari booth.

Shelbourne Software's 3D Breakthrough, the first ST game using the Stereotek 3D Glasses, was a spectacular sight. You move through an elaborate maze by shooting your way through flashy barriers. The disk will also include a non-3D version that doesn't require glasses.

Sorry, gotta cut off now to try for same-day upload. Lots more Atari news from CES will be in our follow-up reports on ANTIC ONLINE.

ATARI SCUTTLEBITS

By Bob Kelly

Reprinted from Current Notes

Computer Market Random Observations

Have you visited a computer magazine store lately? If not, go take a close look. Times are a-changing and some harsh adjustments may be on the way.

One of my most enjoyable pleasures connected with home computing over the years has been reading the monthly computer magazines, whether Atari specific or those for other popular computers. The store I generally visit is located in the financial district of downtown Washington, D.C. It offered the widest assortment of computer magazines of any store I knew. One wall in the store was 30+ feet long and full of computer magazines. Each individual rack on the wall was capable of holding not just one magazine, as is frequently the case in many stores, but 10 to 15. Over time, the magazine overflow spilled onto the floor and to other parts of the store. It was home computer magazine heaven. PC Week always appeared to be most in demand with sales numbering in the several 100's per issue. The Atari related magazines didn't fare too bad with Antic probably the largest seller at 50 to 75 issues per

month.

Lately, this scene has radically changed. In the last eight months or so, the space occupied by computer magazines has been reduced by at least half. In addition, the number of magazines per rack is down. For those magazines still on the shelf, many copies of a single issue are now distributed over multiple racks rather than in one rack as before. Coupling this experience with other information I obtained, it appears computer magazine sales are once again declining.

What does this mean to you? With computer magazine sales trending down, another wave of magazine failures is on the horizon. As for Atari specific magazines, the commercial publications which may be in trouble are primarily directed at the 8 bit market. The likely candidates for failure are no secret! Also, look for some small ST specific magazines to go under. Your bottom line pause and reflect before writing that check to renew your magazine(s) this year. After this reflection, don't fail to subscribe to those you need lest they disappear.

Atari News & Views

Everyone should be aware by now that Atari and Commodore have settled their litigation. The terms of the settlement were not publicly disclosed. There are some interesting aspects to the settlement which I will expand on in a future column.

In April, Atari announced it will be selling \$75 million in convertible Eurobonds to European investors only. Standard and Poor's announced it had assigned a single B- rating to the debentures. On April 14th, Moody's Investors Service assigned an initial rating of a single B3 to the Atari Eurobond issue. Moody, in issuing this rating, stated, "Atari's product line is limited and significant amounts of funds will be required for capital spending and research and development to sustain and broaden the company's narrow product line." Translation, Moody believes Atari is a risky investment. However, you can be a winner when investing in Atari provided they diversify the product line which, in turn, is a function of how much R & D spending occurs.

Some current financial data on Atari follows:

Atari's net income for 1986 was \$25 million versus a (\$14.3) million loss in 1985. As a result of this performance, the price for Atari common stock rose and appears to have settled in the area of \$25 per share, an increase of more than 60% this year. In comparison, the computer industry witnessed a rise of only 33%.

For those of you who believe Atari's low selling prices translate into below average financial returns relative to other firms in the computer



industry, the following table should correct this impression: Atari's profit margin is more than 40% higher than the industry average and look at the relationship of revenue to assets. The motto may be "Power without the Price" to the consumer but to the senior officers and stockholders the motto is more like "Power is in the Profit Margin." Yes Virginia, Atari is a business and very good at it.

Finally, when are people going to stop talking as if Warner Communications no longer owns any portion of Atari. The fact is Warner owns 30% of Atari with Jack Tramiel holding the controlling portion of common stock, roughly 54%.

Timeworks

In my last column, I pointed out how Timeworks' tax program, Sylvia Porter's Swiftax, was not recommended for purchase - a dog, to be explicit. Timeworks has another program which is a WINNER! This judgement is not mine alone, but many have found DATA MANAGER ST to be a program easy to use and flexible, permitting use in varied applications. You would think that Timeworks would do all to promote the sale of this product. Well, you are wrong.

Recently, a close friend of mine called Timeworks inquiring when they planned to introduce a utility that would permit transferring DIF files from other databases into Data Manager ST (DIF stands for Data Interchange Format, a quasi industry standard file format). The response from Timeworks at the other end of the telephone was, "We have had hundreds of calls requesting such a utility. There are currently no plans to make such a capability available to the ST user."

A response such as this illustrates why so many software firms in the past went belly-up. What is amazing is that this attitude still exist today. With a program that could significantly add to total sales, Timeworks should tell the user where to go rather than to go to _____.

Electronic Arts

For all the "old" 8 bit computer owners, Electronic Arts (ECA) is a magic name. This company burst on the scene in 1983 with such outstanding software as M.U.L.E., Archon, and Pinball Construction Set. All of these programs received critical acclaim, brought in substantial sums of money and made Trip Hawkins, the founder of ECA, something of a celebrity.

Trip, after making a good portion of his fortune selling software to Atari owners, abandoned Atari when hard times hit. Hawkins announced that Amiga was the home computer of the future and, by

inference, Atari stood little chance, even with Jack Tramiel. So, Trip had ECA produce software for the Amiga. The Amiga has not lived up to Trip's prediction (one down). In fact, it's the Amiga that's captured only a small portion of home computer market sales while Atari's grew significantly.

Trip, seeing the error of his ways, recently began to produce such "outstanding" pieces of software for the Atari ST as Skyfox (two down).

Undaunted, Trip now believes Starglider to be "the only really outstanding game for the ST" (three down). Thus, he has contracted with Jez San of Argonaut Software to market future programs under the Electronic Arts logo.

Personally, I think Trip is on a trip and it may end abruptly. Given Trip's attitude, I have successfully and with little regret avoided buying ST software marketed specifically under the Electronic Arts logo. This guy must think we're all fools. What did Lincoln say about fooling people some of the time, but not all of the time? Unfortunately, he is taking over a company that produced some of the best software for the Atari - Batteries Included (BI). ECA is purchasing the rights to the BI brand name as well as the rights to market current products. This presents a moral dilemma which I have not yet resolved.

User Hints

While using my ST for the past year and half, I have accumulated what I consider to be some very helpful public domain utilities/accessories. I was asked to name a few of the more important. They are:

ScrSaver.ACC - Blacks out screen without turning off CRT (monitor) switch. A great addition to whatever word processing or database program you may use.

Coldboot.TOS - Click on this little 56 byte program and it cold starts your ST without having to turn the computer switch off and on (from Dec., 1986 Compute ST magazine). Great for clearing accessories out of memory.

Moustrap.ACC - Controls cursor preventing drop down menus from accidentally appearing. To display menus, the right mouse button must be depressed (from Start Magazine, Vol.1, #2). This accessory does not work with any program that requires use of the right button on the mouse such as FLASH.

DCopy19.TTP - This is a shareware program (\$5). It copies, erases, hides, locks, renames, de-arcs files, formats disks and lots more. An all-in-one gem.



These programs are available either on your local BBS, CompuServe, Genie, or the Current Notes library.

See you next time and since I am going to take an extended summer vacation, it will be the September issue.



COMPUTER SKILLS

66 HILSHIRE VILLAGE SHIP CTR
EULESS, TX. 76040
(METRO) 267-5151



ATARI
520 - 1040 ST
COMPUTERS
ST SOFTWARE

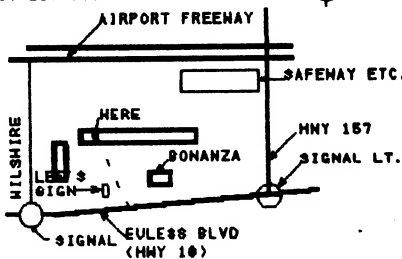

**ATARI - COMMODORE - APPLE - IBM - ETC.
COMPUTER AND PERIPHERAL SERVICE**

DeskCart!

From Quantum Microsystems, Inc.
Reviewed by John Pellet

Finally, a cartridge worthy of the slot in your ST (excluding you Magic Sac fans). Do you want a clock card? How about a screen dump? A ramdisk? Whatever you want, DeskCart! most likely has it. A simple listing: Calendar, Note Book, Card File, Calculator, Typewriter, Address Book, VT-52 Terminal, Keyboard Macros, Ramdisk, Print Spooler, Control Panel, Screen Dump, and Memory Test. Whew! I didn't think I'd get through the list.

DeskCart! adds two files, BOOTCART and BOOTCALC, plus the folder DESKCART to your boot disk. All other files are stored in the folder, unless otherwise specified. How much space the folder uses depends on how aggressive you get in using the various features described below. One of the nicest features in DeskCart! is the file selector

boxes. In addition to all the standard GEM features, you can pick a drive (from A - J), and sort the files on name, size, and date.

As you will notice from the list above, DeskCart! also replaces the standard Atari accessories, Control and Emulate (Desk1 & Desk2). And it does all this while using under 15K of disk space and about 100K of RAM, depending on how much used for print spooling and ramdisk. If this sounds great, read on, for more on the individual pieces.

The Calendar is a simple perpetual calendar, showing a month at a time. It can be tied into an appointment file that will list and alarm any daily functions you wish. Appointment files are stored in the DESKCART folder.

The Note Book is a simple editor. It lets you load, save, and print files. It has a simple search string feature. It doesn't seem to like 80 column files, however. Files are stored in the DESKCART folder with an .NTB extension.

The Card File is a straight-forward data base structured along the lines of an index card file. You can sort the cards on any field, and view or print the results. And, of course, add and delete records. Files are stored in the DESKCART folder with a .DCF extension.

The Calculator is the only function that loads from disk, a file called BOOTCALC.ACC. You get a scientific calculator, including trig and exponential functions, that operates in hex or decimal (I missed binary). Unfortunately, it doesn't understand the algebraic hierarchy (i. e., it says $1+2*3=9$, rather than 7), but otherwise I have no complaints.

The Typewriter simply gives you a way to send a single line to the printer at any time. It works, but there's not too much to say about it.

The Address Book is, as the name implies, a simple name, address, and phone number listing. Beyond that, it will dial any phone number you pick. As above, you can also print your list.

The VT-52 Terminal works just like the standard Atari version. It partially emulates one of the more popular stand-alone terminals out there.

Keyboard Marcos is almost self evident. This works like any of several programs, and if you routinely use key sequences, it stands to save you a lot of keystrokes. You can add, edit, save, and load macro files, stored in the DESKCART folder as MACRO.NTB (default).



The Ramdisk function allows you to size or erase the ramdisk. It does not allow you to assign the drive number, so you must use the next available drive ID.

Disk Utilities lets you copy, delete, rename, and format any file on any active drive, as well as get the free space on any drive. But you cannot copy multiple files, or use wildcards (i. e., * or ?).

Print Spooler does just what its name implies, to free up your computer while your printer finishes printing those 37 graphics screens. You can pick the buffer size and set up the format you want when printing text files. I haven't used it much, since I have an outboard buffer, but those I trust say it is somewhat slow. It purports to work with screen dumps, a somewhat unusual feature.

The Control Panel replaces the Atari accessory, and adds the ability to set the internal clock, and the one used inside DeskCart! You can also elect to display a real time clock in the upper right corner of the screen. It stays there for any GEM program.

Screen Dump lets you load any desired DEGAS format printer driver to replace the standard Atari Epson driver. If supported by the driver, you can select vertical or horizontal format for the printout.

Memory Test is a simple non-destructive test routine, that tests all the ram it finds.

In summary, DeskCart! does a lot for a little, and takes only one accessory slot. Retail price is \$99.95, but is available from local retailers for much less. I heartily recommend it.

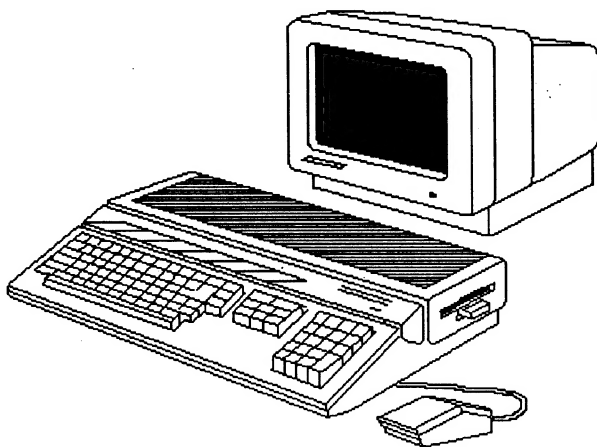

THE HOME ACCOUNTANT

A Financial Application for the ST
from Haba Systems, Inc.
A Review By Rachel Duke

Home Accountant is a financial applications program that can track individual checking, savings, and credit card accounts; keep the family budget, and even pay your bills on time. It can be purchased locally for about \$30.00.

The disk is not copy protected; owners are encouraged to make their own back-ups for their personal use only. This was my first clue that I would enjoy this program - HABA trusts its customers. The second thing I noticed (believe it or not there are some people out here that do read the instructions first) was the listing of two addresses and phone numbers (North America and Europe) for consumer questions. You are requested to read the manual first; if you still have questions (and are a registered user) they will provide you with the best help they can.

Home Accountant is a GEM based program. One of the best features I've discovered about it is that after you've clicked on the program icon you don't have to touch your mouse again if you don't want to. You may use function keys, if you wish, for almost all the mouse-driven commands. This can be THE best feature of the program for those that don't like the hassle of switching back and forth between keyboard and mouse.

The checkbook feature of HOME ACCOUNTANT is easy to use and understand. You may open a new account at any time, or use an existing one. Entering checks or deposits is as easy as using the ones you get from the bank; no explanations are really necessary. If you haven't set up a budget or if you have spent more than the amount you had budgeted for an expense category, an alarm will warn you that you're over budget. If you do not wish to use this feature, simply go to the "reminders" menu and select "budget warnings". To turn it back on just select "budget warnings" again.

If you make an entry, save it and then discover you've made an error, point at the incorrect entry with the mouse, click and it will appear in the check/deposit/draft portion of the screen. Make any corrections necessary and resave.

One thing I find interesting is when using a color monitor the checks, deposits, and drafts will be displayed in different colors. The actual colors will depend on the colors you have set



in your control panel. You can also arrange the check register by number, date, payee, category or whether a check has cleared the bank or not. However, you don't need color to run HOME ACCOUNTANT - it runs in either color or monochrome.

All right, let's be honest here. How many of you out there have gone to the store and made a purchase with a check that included several categories. Let's say you bought \$10 worth of groceries and spent \$5 on renting a video tape. When you went home you put the \$15 check under either groceries or entertainment because your financial/budget program wouldn't let you enter a check twice. The Home Accountant solves this problem by letting you split one check between two or more categories. I haven't decided yet whether I really like this feature or not. My entertainment expense has jumped considerably since switching to this program.

You may set up your budget for the year, with up to 16 income and 80 expense categories available. For fixed expenses, you need not enter the amount once for each month; there is a "fill" feature that does it for you.

One of the least desirable aspects of this program (through no fault of its own) is the budget reminder. This is the little dialog box that appears whenever you make an entry that exceeds the budget you entered. (Believe me, I'm very familiar with this part of the program.) At this point, I usually turn off this feature; but for those of you who are gluttons for punishment, this can be a very helpful tool in maintaining your finances.

The credit card account is set up very similar to the checking account. You may either view your credit cards by how much credit you have left on each one or by how much you have used. Something else I like is that you can use this feature for everything that you make monthly payments to. I find it much easier to look up the balance of a particular account using HOME ACCOUNTANT than pulling all of my bills out of the bill drawer and sorting through them all.

I find the reminder feature exceptionally useful. You can enter all your monthly bills into a Bill Reminder Register, and the program will remind you when a bill is due. To pay the bill, simply click on the entry or entries you wish to pay then click on "write checks". The program will automatically enter the check into your computer checkbook and print out the check on your printer. (In the packaging for this program is an order form for pin-feed checks.) This can make bill paying night a breeze (as much as spending money on bills can be).

This little jewel of a program can also reconcile your bank statement, reconcile your credit card statements and print eight different reports that let you know exactly where your money's going.

Personally, I have found my financial program for life. My husband brought home DOLLARS AND SENSE the other day. To keep peace in the family I entered all the required information so now I keep track of the family expenses on HOME ACCOUNTANT and he keeps track of them on DOLLARS AND SENSE. I highly recommend this program to those of you out there that want to take care of your finances without being an accountant.

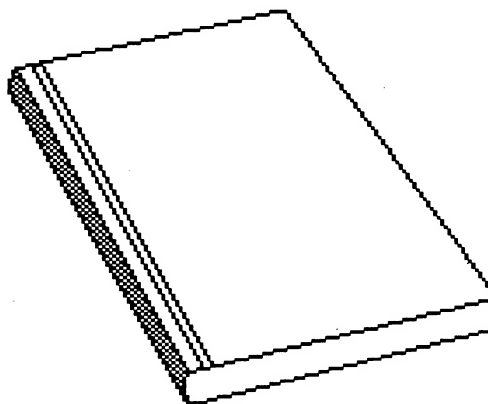

THE ATARI ST FOR BEGINNERS

A Book From Abacus

Reviewed by Angela Burns

We all got a book with our STs that was supposed to tell us exactly how to use them. That book was all right for someone who had been involved with computers for any length of time, but when my husband leafed through it, he was thoroughly confused. (Having a spouse who rattles on about computing day and night doesn't count as being "involved". Especially when you ignore as much of it as you possibly can.) So what about the brand new "computerphile"? Is there a book available to him/her that was easily understandable? YES! Never fear, ABACUS BOOKS is here!

THE ATARI ST FOR BEGINNERS is a clear, concise explanation of the very basics of computing with the ST. It's the perfect volume for the new ST owner who has never before been exposed to computers.



Chapter one is devoted to simply setting up the ST and editing all the proper plugs in all the proper places. Information is primarily directed toward the 520ST, with any differences between it and the 1040ST so noted. Good photographs are provided, with all ports labeled clearly. If you were going to use this book from the very beginning, you could hardly mess up if you TRIED.

Chapter two starts out with the GEM desktop and lets you play around with it for a while: dragging icons around, moving windows, scrolling through directories, etc. It then tackles the drop-down menus one at a time, explaining each feature that pops up when you point to it. You are led through the copying of your language diskette, before you have a chance to play enough on your own to erase it or something equally horrible. Finally, this chapter explains all about files, folders, icons, and all of the keys.

Chapters three and four cheerfully attack the subject of languages. Chapter three handles ST BASIC and chapter four takes over with LOGO. They begin by explaining what programming languages are and, in general terms, how they work. The authors go on to demonstrate some of the most basic commands, illustrating the concepts with cute pictures and a few simple programs. This is not enough to really understand either language; for that, you will need your manual. But it will get you started in the right direction.

Chapter five is the best in the book (in my humble opinion). This is where you get the interesting stuff. Titled "A lesson in hiSTory", this chapter begins in the forties with the electromechanical relay calculator built by German Konrad Zuse (on display in the computer history exhibit of the National Museum in Munich). It explains all about ROMs, PROMs, EPROMs, and RAMs. You name it, this chapter covers it. The binary, octal, and hexadecimal systems of numbering are explained fairly well, followed by kilobytes, CPUs, peripherals, and software (notably that which can be ordered from ABACUS on the back page).

The epilogue, also in chapter five, tells of the development of the ST and the Tramiel Operating System. (I wondered what TOS stood for.)

Appendix A displays the entire ST character set and tells which key combinations to press to obtain international and special characters. Oddly enough, they don't say which keys to press to get which characters; just which key presses will give you some special character or another. You'll just have to press all the combinations and see what you get. It would have been nice to have a chart for this, but for most of us it's not a vitally important feature of the computer anyway.

Still, I was disappointed with the lack of a chart, in view of the fact that the rest of the book seemed so thoughtfully put together.

Appendix B contains programs to help you convert numbers among the three most widely used numbering systems: decimal, hexadecimal, and octal.

Appendix C is a mini-glossary for computer users. It gives definitions for most basic computing terms, even mentioning retired Admiral Grace Hopper's tale of the origins of the term "bug" to describe problems in a program or system. (In case anyone cares, one of the relay computers crashed in the forties; the cause was found to be an actual insect, a moth, which had gotten into the machinery.)

Appendix D gives the meanings and remedies for a number of the most common ST error messages. They are in plain English, like the rest of the book. There is nothing here to misunderstand.

You may think this weird, but I have an index fixation. It drives me crazy to be trying to understand something in a computer book and not be able to find ANYTHING in the index. It seems to be a rule in the computer publications industry. Well, believe it or not, this book's index is as good as gold. I looked up everything I could think of that had been covered in the book, and I found it ALL in the index. Not only is it in there, but it's actually listed under headings that a normal person might be tempted to look under. ABACUS is to be congratulated for breaking the index barrier and recognizing that someone might actually want to look something up.

This is not the book for you if you possess even the basics of computer knowledge. You can do just fine with the ST manual. If you're a new user, it's a "must have". THE ATARI ST FOR BEGINNERS is just that - for beginners. It can make life a great deal easier for the newcomer to personal computing.

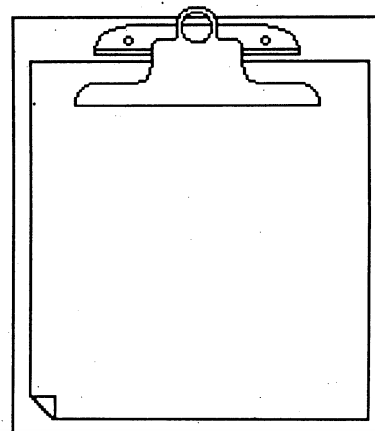



**COMPLETE
1040 ST
COLOR SYSTEM
\$ 899.95
AVAILABLE TO USER GROUP
MEMBERS ONLY**

**NOW EVERYONE CAN
OWN A PRINTER
NEW LOW, LOW PRICE
STAR NP 10
\$ 149.95**

**100 CPS DRAFT, 25 CPS NLQ
EASY FRONT PANEL OPERATION
AUTO PAPER FEED
BUILT-IN RECESSED TRACTOR
OUTSTANDING PRINT QUALITY**

OFFER EXPIRES JULY 31, 1987



**COMPUTER DISCOVERIES
12801 MIDWAY RD.
SUITE 109
DALLAS, TX 75244
(214)-484-9104
HOURS 10 AM - 6 PM
"YOUR PREMIER 8 BIT
AND ST DEALER"**

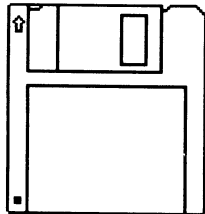

**DISK SALE
GENERIC 3 1/2 S/S D/D DISKS**

BOX OF 10 \$9.95

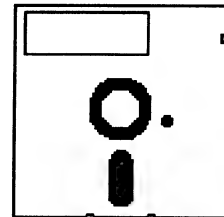

**NEW LOW PRICE
PICO SURGE
PROTECTOR**

\$ 49.95



COMPLETE WORD PROCESSING PACKAGE

ATARI 1040 ST

The new Atari 1040 ST personal computer system gives you much more - For Much Less

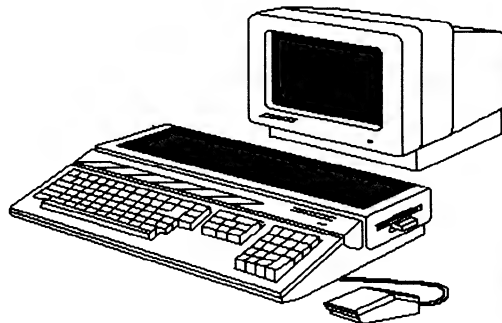

Why pay more for another computer when you can get a 1040ST for hundreds of dollars less! For only \$ 899.95 the Atari 1040ST comes complete with a 2 - button mouse, 3.5" disk drive, high resolution monochrome monitor, and TOS Operating System, which includes GEM desktop graphics. Judge for yourself. You'll agree the New Atari 1040ST Personal System is the best !!

ATARI 1040ST
\$ 899.95
Retail Value over \$1500
complete color system
\$ 1099.95

FREE SOFTWARE Packed with your 1040ST, at no extra charge are 3 great software programs:

ST BASIC to create programs

WORD WRITER ST is the perfect word processing package for all letter and business **WRITING**. Includes spell checker, thesaurus, and mail merge.
NEOchrome Sampler is a full-color painting program.

Package also includes:

STAR NP10 PRINTER

HI SPEED DOT MATRIX PRINTER WITH
EXCELLENT NLQ PRINTING

COMPUTER DISCOVERIES

12801 MIDWAY RD. #109
DALLAS, TX 75244

484-9104

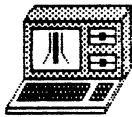

Megamax C

for the
Atari ST

featuring
ONE PASS COMPILE
IN-LINE ASSEMBLY
SMART LINKER
FULL ACCESS TO GEM ROUTINES
REGISTER VARIABLE SUPPORT
POSITION INDEPENDENT CODE
...AND MUCH MORE...

SYSTEM INCLUDES:

FULL K&R C COMPILER
(with common extensions)
LINKER..LIBRARIAN..DISASSEMBLER
C SPECIFIC EDITOR..CODE IMPROVER
DOCUMENTATION..GRAPHIC SHELL

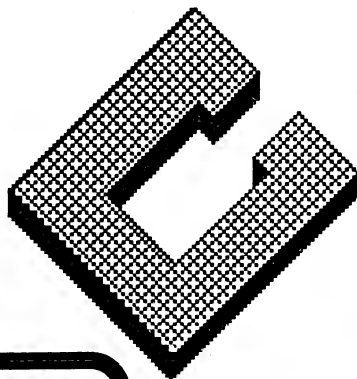

Available at Computer Discoveries
12801 Midway Rd. #109
Dallas, Texas 75244
484-9104

\$199.95 For more information call or write:

Megamax, Inc

Box 851521
Richardson, Texas 75085
(214) 987-4931

VISA, MC, COD ACCEPTED

MANY THANKS TO
MEGAMAX FOR THEIR
HELP IN PUBLISHING
THIS NEWSLETTER

RAM



ANTIC'S JUNE '87 ATARI CES REPORT: NEW 8-BIT PRODUCTS

By Nat Friedland, ANTIC Editor

ANTIC Publishing Inc., Copyright 1987.
Reprinted by Permission.

"Okay, all those letters this month from Antic readers have convinced us there's still an 8-bit Atari market out there," said Springboard Software president John Poulson at his company's CES booth. "You'll be glad to know that Springboard has now started work on an 8-bit Atari version of Newsroom.

Newsroom is a popular entry-level page layout program for easy newsletters. Springboard is already showing an ST version of their Certificate Maker here, this product is currently shipping.

Good news for Atari graphics users who have been trying to find a touch tablet. Suncom's Animation Station for XL/ XE is now available. The included software provides many pre-drawn pictures as well as automatic shape generation. The tablet can be used in place of joysticks or paddles to control any standard Atari software, according to Suncom.

At Antic's suggestion, Suncom is now looking into converting their convenient keyboard-mounted joystick for use with the Atari 8-bit and ST.

Strategic Simulations Inc. had extra reason for celebrating at their suite, high above the Chicago River. Last week they signed a contract with TSR to start the first computer versions of the original Dungeons and Dragons games. You should be able to play D&D on your Atari by Christmas.

Datasoft, now being released through Electronic Arts, has two welcome 8-bit titles due out before July. Video Title Shop (\$29.95) lets you create colorful animated sequences with graphics and moving text -which can be transferred to your video recorder tape via standard electronics cables. Video Title Shop includes the Micro-Painter Plus paint program and a library of built-in borders and screen images. Scrolling, position-changes, fadeouts and a whole range of video special effects are supported. A second disk of video "clip art" for the program will also be released this year.

Also from Datasoft at \$29.95 is the second installment of Alternate Reality - The Dungeon - which seems to play much faster and more conveniently, with less disk swapping than the earlier installment of this large-scale graphics adventure game.

Most of the unreleased software on display at CES was promised for shipment by early summer. One of the few new packages I was actually able to bring back for review is...Virtuoso. This is the long-evolving music/graphics storyboard system that Antic previewed almost two years ago. The XL/XE version is \$49.95 and the ST version is reportedly well along in development.

Infocom had two of its top adventure programmers on hand at the show - Dave Lebling (Lurking Horror) and Steve Meretzky (Stationfall, Hitchikers Guide). Brian Moriarty was left home in Boston to continue working on the new Beyond Zork project which will blend role-playing with the text adventure format. Activision, Infocom's parent company, had only two arcade cartridges for the Atari 2600, Kung Fu Master and Commando.

The fourth (and final) ANTIC ONLINE report from the June '87 CES will feature tonight's second annual ChicagoLand Atari Users Group dinner meeting, which is attended by many top executives and programming professionals from the Atari world.

ST NEW PRODUCTS

What looked like a very powerful and easy-handling 2-D drafting and drawing program was being demonstrated by Xetec of Salina, Kansas (makers of the Grafix AT which has been reviewed in Antic). SCAD gives you pages for 16 ST drawings in RAM. All commands can be operated from GEM or from the keyboard. The \$99.95 program is due in September and will not be copy-protected. Page sizes can be defined as large as 32 X 32 inches and many powerful graphics editing tools are built-in. SCAD can convert images into DEGAS format. We'll also be reviewing Xetec's new Printer Enhancer, a \$249.95 buffer/switcher with 8 built-in type fonts.

A software team from Venezuela was showing MasterCAD 3-D, a \$199.95 program that converts any 2-D image into real 3-D and seems quite easy to operate. The current version requires 1Mb and monochrome. Final U.S. distribution is still being set.

Passport Designs, a leading MIDI software house, is rushing to convert its first ST product - Master Tracks Pro, a high-powered, user-friendly 64-track sequencer that has been winning rave reviews on the Macintosh this spring. The Passport CES team told Antic that three out of four visitors to their booth wanted this product on the ST instead of the Mac.

Computereyes, a 1986 Antic Award Winner, is being shown at CES in an inexpensive \$149.95 monochrome version (it can produce gray scales on



the color monitor). This is the latest Atari video digitizer from Digital Vision. Their ST color unit will be reviewed in the August 1987 issue of Antic.

Another specialized new use for the ST is to run a graphics database for serious chess players. SciSys of London is showing two versions of ST ChessBase - the software that current World Champion Garry Kasparov has been using to prepare himself for tournaments.

With Chessbase Sr., every recent tournament game of an upcoming opponent can be fed into the database and instantly examined from a vast variety of viewpoints to pinpoint potential weak points of play. You can see how an opponent reacts to any standard style of opening or strategy. ChessBase Jr. works with the expensive Leonardo world-class chess computer and the ST. U.S. distribution for all these products was being finalized at CES.

An add-on to PrintMaster Plus, the Print Shop workalike from Unison World, will be a Fonts and Borders disk. Price is not yet set.

GAME GALLERY

Microprose had a customized Link Trainer "flying" on the CES floor as it was piloted with the new Gunship helicopter simulation. The ST version is still under development.

Mindscape, which hosted a Sunday rock oldies concert for 1,000 (Bo Diddley, Sam & Dave) showed two \$29.95 ST color games designed in England. Q-Ball is a 3-D billiards game played inside a cube where you can adjust the gravity and line up your shots off any wall. Plutos is a shootout where your rocket flies over the scrolling surface of the huge enemy mothership and attempts to destroy it.

From England's Psygnosis, creators of the visually awesome graphic adventure game Brataccas, comes another lushly-detailed extravaganza. Barbarian moves a Conan-type hero through an a vast, scrolling underground kingdom - color only - where monsters and hordes of enemy guards must be overcome on every screen.

Electronic Arts is starting to crank out some ST titles too. An enhanced version of Music Construction Set - with MIDI - is due in July for \$39.95. Other new features are direct waveform editing and a jukebox playback mode.

EA has also taken over distribution of the First Byte talking ST software. First releases are MathTalk, a flashy arithmetic drill for youngsters, and a computer version of Mad Libs, the popular series of humor books where you add inappropriate words to prepared story lines.

Still more from Electronic Arts, a kind of super-Diplomacy strategy game called Empire, where you conquer weaker parts of the world and force them to build weapons and raise new armies for your war machine. But your enemies are just as ruthless, and you can also start the game by re-drawing the map of the world to suit your own tastes.

Logical Design Works has a whole line of fast-moving ST gambling simulations for \$34.95 each. Vegas Gambler combines blackjack, roulette, slot machine and poker machine. Other titles available are Vegas Craps and Club Backgammon.

From Canada Jagware is making its ST debut with Alien Fires, a color-only 3-D space maze arriving this summer.

AVATEX 2400 BAUD MODEM

Avatex, well-known for its low-priced Hayes-compatible modems, now has a speedy 2400 baud unit. List price is \$319 but previous Avatex modems have been dramatically discounted. (JLP Note: I have one, seems to work GREAT. Look for review soon.)

We ran into some offbeat items for souvenir-hungry Atarians. Classic Covers offers protective covers for Atari computers, monitors, disk drives and printers - all emblazoned with a big golden fuji symbol and the Atari name.

Another company was showing credit-card-sized pocket calculators featuring the fuji and Atari name.

By the way, Atari used the CES opening to announce that they had a 45% increase in first quarter sales this year - \$65.1 million - and they were making a 2-for-1 stock split.

This news bumped up the price of Atari stock by about \$5, to over \$30 per share.

Towards the end of the Consumer Electronics Show, we got our first look at some additional important ST software:

Broderbund is jumping into the ST marketplace with Art Director and Film Director, a DEGAS-quality paint program that will be packaged together with an animation module for \$79.95. This software, originally designed by the Hungarians who did ST Battlezone, is expected to ship in August. Features include: rescale, stretch, distort, bend, bulge, spin, perspective, scroll and spin.

Not quite as far along is the ST version of Broderbund's all-time best seller, Print Shop. It is due this fall at \$49.95 and will be similar to the



sophisticated Macintosh version. Also coming from Broderbund this fall is the ST Karateka at \$34.95.

Timeworks Desktop Publisher this fall will join the company's ST word processor, spreadsheet and database software.

Spitfire 1940 is an ST flight combat game coming from Avalon Hill this summer. We also picked up an 8-bit review copy of their Guderian wargame.

And back at the bustling Atari booth, we got a look at Bentley Bear Goes To School -- a new ST educational series programmed in Israel and featuring the lovable bruin from the Crystal Castle arcade game. Four titles for grades K-6 are to be marketed within 30 days and there will eventually be some 20 in the series. The animation in each title such as Magical Mathematics is of very high quality and the packages will sell for \$19.95 apiece.

ANNUAL ATARI ROAST

In its second year, the CES Monday night dinner of the ChicagoLand Atari Users Group (CLAUG) has become the Atari community's de facto annual roast.

On the evening before CES's final day, CLAUG invites a bus load of executives and programmers from Atari and independent companies to dinner at a college dining hall in the western suburbs, about as far from town as O'Hare Airport.

After the visitors refuel themselves following a hectic day at the show, the event becomes a regular CLAUG meeting with every professional making a statement and answering questions.

This year Atari vice president Leonard Tramiel revealed that a 16-bit graphics workstation is in a fairly advanced stage of development. This would be compatible with the ST but much more powerful. He said that any 32-bit multitasking computer would need to run Unix, but it was a problem deciding which competing version of Unix would be best.

Marketing communications director Neil Harris stated that ST Word Perfect, due in July, runs five times faster than the best selling IBM version.

Harris explained that Atari's top priority at this particular CES was to revitalize the 8-bit line by packaging a redesigned 65XE as a high-end game system, in direct competition with Nintendo and

SUMMER CLEARANCE SALE
25% OFF ANY ORDER

Z-Time™

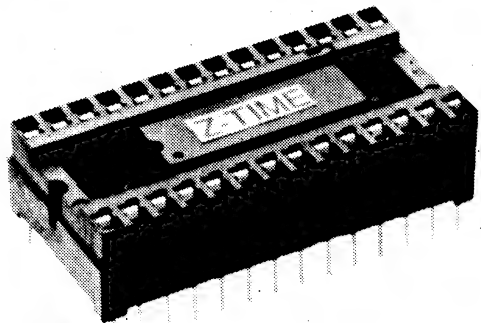

- Battery back up clock chip for 520ST and 1040ST
- Chip sized: does not take up cartridge port
- Simple **solderless** installation. Plugs into ROM socket on mother board
- Super reliable 10 year lithium battery
- Accurate to within 30 seconds per month
- Includes utility and system software
- 6 month warranty

520 version list \$49.95
1040 version list \$59.95

Terrific Corp.
17 St. Mary's Court
Brookline, MA 02146
617-232-2317
User group discounts available

ZTime, is a trademark of Terrific Corp. Atari and Atari 520ST are registered trademarks of Atari Corp.



Sega. That's why the Mega ST and the Atari Laser Printer were not displayed this time. According to Harris, the XE Game System was receiving an enthusiastic early response from mass-market purchasing agents.

MORE XF551 AND ADOS

Here's some additional details about the new Atari 8-bit disk drive and other Atari hardware.

Essentially, the XF551 is an adaptation of the standard disk drive mechanism being used for Atari's IBM clone. The 360K, double-sided, double-density 5 1/4 inch disk drive runs 2.9 times faster than the Atari 1050 and is due in the stores this summer at a \$199.95 list-price.

The XF551 can automatically adapt itself to today's single density and enhanced density DOS disks. However, ADOS, the new OSS operating system coming with the XF551 includes a tree structure allowing subdirectories, easy switching between menus or keyboard commands, and a high degree of file recovery safety.

Bill Wilkinson of OSS says that ADOS will run on any Atari-compatible disk drive, from the old 810 to a 16Mb hard disk. Although 8Mb is the upper limit for efficient operation, a larger hard disk can be partitioned into several logical drives. DOS 2 and 2.5 files can be read into ADOS, but ADOS is not fully compatible with the older operating systems.

Along with the XF551, the Atari products announced in January at the previous CES are now also scheduled for summer release. This impressive list includes the Mega ST in 1, 2 and 4 megabytes, a \$1,500 laser printer, the Atari PC clone, the \$150 XE Game System version of the 65XE, the 80-column XEP80 display box and the 1200-baud SX212 modem.

By the way, Atari is going back to Chicago in three weeks, where it will show off the ST's MIDI power and become the first personal computer company ever to exhibit at NAMM, the musical instrument industry's show.

Buy From The Hard Disk Experts!

ATARI XL/XE

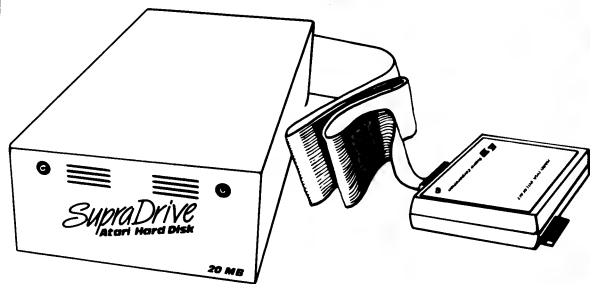

20 MB Complete System \$ 699.00

Includes Hard Disk Interface with hi-speed parallel port. MYDOS disk operating system and 3.5 inch 20 MB Hard Disk.

Interface and Software Only \$ 149.95

ATARI ST

Build Your Own System!

Includes Supra's proprietary Hard Disk Interface and Boot Software. You add a Surplus Hard Disk, Controller and Case for a complete system.

Interface W/ Boot Software
Only \$ 119.95

Complete Systems:

20 MB \$ 699.00
30 MB \$ 995.00
60 MB \$1995.00
250 MB \$3995.00



Available at your local dealer, or call

 **Supra Corporation**

1133 Commercial Way / Albany, OR 97321 / (503) 967-9075

System HD+ by Astra

2 DRIVES IN ONE !

LET'S TALK QUALITY!

- * Top of the line components !
- * Superior design !
- * Extreme care in assembly !
- * Scrupulous testing !

LET'S TALK CONVENIENCE!

- * 20.8 megabyte hard-drive (formatted) !
- * Double sided 3.5" floppy drive !
- * Internal power supply !
- * All in one neat, strong, housing !

LET'S TALK FEATURES...

- * 36" hard drive cable lets you place unit conveniently, not on top of your keyboard !
- * A single AC powercord replaces power supply and two powercords !
- * Lighted front switch lets you turn unit on without a lot of gymnastics !
- * Lighted busy lights tell you when your hard drive and floppy drive are working !
- * Our small footprint (5 1/4"W, 4 1/4"H, 12"L) saves space on your crowded desk !

LET'S TALK WARRANTY...

We have taken extreme steps to insure the quality of these units. Therefore we feel confident enough to offer a ONE YEAR LIMITED WARRANTY covering defects in both parts and labor. This is four times as long as usually given in the industry!

LET'S TALK FUN !

Until you have experienced the fun and convenience of using a hard disk, you have missed a lot of the fun you expected from your computer. Faster access to programs and data make for more fun and less waiting !

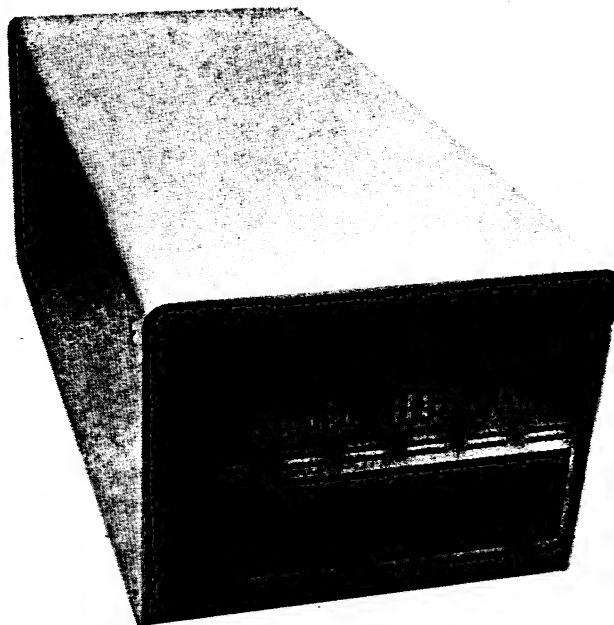

LET'S TALK FREEBIES !

We supply complete formatting and partitioning software. (So does everyone else.) We also supply BRS, a unique backup and restore program that will back up your valuable files to floppies. This is a \$39.95 value. And when you return your registration card to us we will send you a free "Mousterpiece" mouse pad !

LET'S TALK TURKEY...IT'S AT YOUR DEALER NOW !



New 8 Bit Disk
86
ARC
and
Arc Utilities

up nights, eagerly anticipating all the wonderful things you're all going to write. So get on the phone or the BBS right away - we need YOU!

Ed. Note: Right now the club is in desperate need of volunteers for the kiosk before meetings. And we also need a new CCD representative, This only requires one evening a month and it is very important that our club be represented at the CCD meetings. If you are willing to help in either of these areas please contact one of your officers.

FROM THE CO-EDITOR

A plea from Angela Burns

First, I would like to thank the board for giving in to my begging and pleading to help edit the newsletter. This is great! I'm having more fun than you could believe! Thank You, thank you, thank you!

Now for some good groveling. Our club is named the Dallas Atari ENTHUSIASTS. That means we're ENTHUSIASTIC, right? So, show me some of that ATARIAN enthusiasm, and contribute to YOUR newsletter. I'm even going to make it easy for you. You don't have to write a full blown article. Just get in touch with me via the ST BBS or leave a message with Jim and Rachel Duke. Give me your ideas or opinions on software, hardware, the meaning of life (42), or ANYTHING! If you can get your ideas anywhere near where an English speaking person can halfway understand them, the trusty newsletter volunteers will take over from there. You don't have to worry about spelling, grammar, punctuation, or any of that nasty stuff; that's our problem.

There are other areas where the club could use your assistance, too. Newsletter distribution, help at the kiosk downstairs, and demoing products, just to name a few. You don't have to know a whole lot or have been a member since the Dark Ages to help, either. I've only been a member since November, the ST disk librarian for about the same length of time, and plenty of AtariFest volunteers were brand-new members! And believe me, I am about as far from being a computer expert as one person can get. You'd be surprised to find out how much you know!

Remember, the club is YOU. Without you, we have nothing. We have one of the most outstanding users' groups in the country now, but we can make it even better! I'll be waiting to hear from you, sitting

New ST Disks

#74 & 75
Games

#72
Public Domain
C Compiler

#73
Talking
Educational
Demo



DAL-ACE SURVEY 1987

Time for another survey. Please answer the questions below, so we may keep up-to-date on just what kind of people are in DAL-ACE, how the club and your computers affect your lives, and what you want out of your club and newsletter. Please do not sign your name; all answers will be kept confidential. Feel free to add any comments you like.

HARDWARE

1. How many computers do you own? ___ one ___ two ___ three or more
2. What kind(s) are they? ___ 400 ___ 800 ___ 600XL ___ 800XL ___ 1200XL
___ 65XE ___ 130XE ___ 520ST ___ 1040ST _____ other (please state)
3. What was your second choice?
4. Why did you choose Atari?
5. What modifications (if any) have you added? ___ memory upgrade ___ new OS
___ 80-column board ___ other
6. how did you first learn of Atari computers? ___ friend ___ store ___ advertisements
___ work ___ school ___ other
7. Do you use computers ... ___ at work? ___ at home? ___ at school?
___ none?
8. How much have you invested in each system you own? _____
9. Do you buy your computer equipment and software primarily from ___ local dealers
___ mail order houses ___ the club ___ garage sale table
10. Do you have a (check all that apply)... ___ cassette recorder ___ floppy disk drive
___ hard disk drive ___ monochrome monitor ___ color monitor ___ daisywheel
printer ___ dot matrix printer ___ laser printer ___ 300 baud modem 1200
baud modem ___ 2400 baud modem _____ other (please state)

SOFTWARE USAGE

11. Rank the types of software below in order of usage. 1 = frequently used,
2 = occasionally used, 3 = seldom used, 4 = never used
___ word processors ___ educational ___ music ___ games ___ databases
___ spreadsheets ___ graphics ___ telecommunications ___ personal finances
___ engineering ___ CADD ___ business ___ programming
12. If you do any programming, what language(s) do you most often use?
___ BASIC ___ PASCAL ___ C ___ FORTH ___ MODULA 2
___ LOGO ___ ASSEMBLER _____ other (please specify)
13. How much (total) have you invested in the following types of software?
games \$ ___ graphics \$ ___ applications \$ ___ utilities \$ _____
14. Do you purchase disks from the club library regularly, occasionally, or never?
(Circle one) Why or why not? _____

CLUB

15. How do you hear about DAL-ACE
20. Do you regularly attend club meetings? ___ yes ___ no
21. Do you attend SIG meetings when available? ___ yes ___ no
Specify SIGs that you regularly attend. _____
22. What would you like to see the club do that it's not doing now?

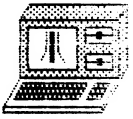

- 23. What are you interested in doing for the club... _____
- 24. Would you like to see more... _____ classes? _____ SIGs? _____ tutorials?
_____ demos? _____ other (please specify)
- 25. What would you like to see more of in your newsletter (Check all that apply.)
_____ editorials _____ software reviews _____ hardware reviews
_____ Atari Corp. news _____ tutorials _____ graphics _____ info on new products
_____ ideas / philosophy _____ telecommunications
- 26. What are you willing to write for the newsletter? ... _____
- 27. What do you think there is too much of in the newsletter? _____

BBS USAGE

- 28. Do you call DAL-ACE BBS #1? _____ #2? _____
- 29. Is it a local call? Yes _____ No _____
- 30. Are you happy with the quality of our bulletin boards? Yes _____ No _____
Why or Why not? _____

YOU

- 31. Age _____
- 32. Sex _____ (This is not a yes or no question)
- 33. What is your average income (yearly)? 0-10,000 _____ 10-20,000 _____ 30-40,000 _____
40-50,000 _____ over 50,000 _____
- 34. What is your highest level of education? _____ none _____ high school _____ Some college
_____ associate degree _____ bachelor's degree _____ master's degree _____ ph.d.
- 35. What is your professional field? _____ professional _____ technical/scientific
_____ managerial _____ service _____ student _____ retired _____ unemployed

Please mail your answers to:

NEWSLETTER EDITORS

SURVEY RESULTS

P.O. BOX 851872

RICHARDSON, TEXAS 75085-1872

The deadline for returning your completed survey is the August club meeting. I will have the results tabulated no later than the September Issue of the newsletter. Give us a hand. Let us (and our advertisers) know who you are and what you want! We can't do it for you if you don't tell us!



NEWSLETTER SUBMISSIONS

Submissions are welcome in ANY form. However, it is extremely helpful if submissions conform to one of these formats:

1. ASCII files with no formatting information
2. On ST format disk
3. Uploaded to either of the DAL-ACE BBS's
4. Publishing Partner file

CURRENT DAL-ACE SCHEDULE

- Saturday August 8 Main Meeting**
- Sunday August 23 Newsletter Production**
- Saturday September 12 Main Meeting**

INFOMART DIRECTIONS

From North Dallas, take either Stemmons (I-35 E) or the Dallas North Tollway. From Stemmons, take the Oak Lawn exit, turn east (left) and park at Infomart, on the left just after you go under Stemmons. If you're using the tollway, exit right on Wycliff, go left on Harry Hines to Oak Lawn and turn right. Infomart will be on your right. From the south, take Stemmons north then follow above. Infomart is the big white steel and glass building south of the other 'marts. The main entrance faces Stemmons. GUESTS ARE WELCOME!!!!

*** MEETING INFORMATION ***

- | | |
|----------------------|----------------------------|
| 11:00 - 11:30 | Main Meeting |
| 11:20 - 12:00 | BBS Users |
| | New Users |
| | Newsletter Exchange |
| 12:00 - 1:30 | ST SIG |
| 1:00 - 2:30 | 8 BIT SIG |

NEWSLETTER ADVERTISEMENTS

Personal sale ads are free to members.
See editor for details.

COMMERCIAL AD RATES

Full Page	\$35.00
Half Page	\$25.00
Quater Page	\$15.00

Long term rates are available. Contact our advertising manager for details.

Ads must be CAMERA READY. Copy must be recieved PRIOR TO the production meeting. Mail copy to address on back page, or contact the advertising manager. Copy received after the deadline will be run the following month. For contract advertisers, if no new copy is received by the deadline, then the most recent ad will be re-run.

SPECIAL THANKS!

We would like to express our appreciation to Megamax, Inc. for allowing us to use their laser printer for our newsletter.

Special thanks also to our advertisers for supporting Atari and Dal-Ace. Be sure to let them know how much their support means to Dal-ace.

DISCLAIMER

The material in this newsletter reflects the opinions of the authors. Opposing opinions are solicited. Unless otherwise stated, this material is NOT copyrighted and no rights are reserved. The purpose of the newsletter is to present information for your consideration. Neither the editor nor DAL-ACE make any claims for the validity or usefulness of this material. The reader is the final judge of any product or advice presented.

DAL-ACE OFFICERS

PRESIDENT Larry Dineen 817- 668-7296
VICE-PRES Michael Trombley 255-9832
VP Comm James Duke 790-2643
SECRETARY Rachel Duke 790-2643
TREASURER Don Adams 350-2206
M.A.L. Michael Duke 414-1132
M.A.L. Nolan Terrill 255-8357
M.A.L. Wally Wilinsky 506-0352
M.A.L. Robert Childress 692-1204

DAL-ACE VOLUNTEERS

Editors Scott Phelan 492-2731
 Angela Burns 790-2643
Ad Manager ... Don Adams 350-2206
BBS James Duke(ST) 986-7753
 Michael Trombley 255-8833
8 Bit Library ... Michael Duke 414-1132
ST Library Joe Camblin 221-7825

Dal-Ace BBS #1 214- 255-8833
Dal-Ace BBS #2 214- 986-7753

DAL-ACE Dallas Atari Computer Enthusiasts

DAL-ACE is an independent, user education group not affiliated with the ATARI Corporation. This is the official newsletter of DAL-ACE and is intended for the education of its members as well as for the dissemination of information about Atari computer products.

DAL-ACE membership is \$16.00 per year. This newsletter is written, edited, and published by volunteers. Its availability and/or distribution may, at times, be subject to circumstances beyond the control of the club officers. Members will note that their renewal date appears on their address label. A pink label means that your membership expires this month!

Other user groups may obtain copies of this newsletter on an exchange basis.

ALL MATERIAL IN THIS NEWSLETTER MAY BE REPRINTED IN ANY FORM, PROVIDED THAT DAL-ACE AND THE AUTHOR, IF APPLICABLE, ARE GIVEN CREDIT. LIKEWISE, PORTIONS OF THIS NEWSLETTER ARE REPRINTED FROM OTHER NEWSLETTERS AND ARE SO NOTED.

DAL-ACE

P.O. Box 851872
RICHARDSON, TEXAS 75085-1872

U.S. POSTAGE PAID
BULK RATE
PERMIT NO. 1203
RICHARDSON, TX 75080

